



HARDWARE GUIDE

Boiler Controller C1050 Series

Specifications and Operational Guide

www.proloncontrols.com | info@proloncontrols.com
17 510, rue Charles, Suite 100, Mirabel, QC, J7J 1X9



Table of Contents

General Information	4
PL-C1050 Boiler Controller	4
Description.....	4
General Behaviour.....	4
Operating Sequence.....	5
General.....	5
Parallel Pump Sequence	5
Follower Pump Sequence	5
Components.....	6
Component Identification.....	6
LEDs.....	7
Address Configuration for Networking	7
Input and Output Identification.....	8
Inputs.....	9
Analog Input.....	9
Temperature Sensors.....	9
Proof of Pump	10
Outputs.....	11
Output Specifications.....	11
Configuration of Digital Outputs.....	11
Typical Connection of Digital Outputs	12
Typical Connection of the Analog Output.....	13
Power Source / Network.....	14
Power Source.....	14
Network Communication.....	14
Technical Specifications	15
Compliance.....	16
FCC User Information.....	16
Industry Canada	16
Overall Dimensions	17



Table of Figures

Figure 1 - Component Identification	6
Figure 2 - LEDs Identification	7
Figure 3 - Addressing Dipswitches	7
Figure 4 - Input and Output Identification (Staged Boiler)	8
Figure 5 - Input and Output Identification (Modulating Boiler)	8
Figure 6 - Analog input	9
Figure 7 - Connecting the Temperature Sensors	9
Figure 8 - Connecting the Proof of Pump Contacts to the Controller	10
Figure 9 - Output in SOURCE mode	11
Figure 10 - Output in SINK mode	12
Figure 11 - Connection of Active Outputs 3 and 4	12
Figure 12 - Connection of Passive Output 3 and 4	12
Figure 13 - Connecting the Analog Output (Controller Powered)	13
Figure 14 - Connecting the Analog Output (External Power)	13
Figure 15 - Connecting the 24VAC Power Source	14
Figure 16 - Connecting to the Network	14
Figure 17 - C1050 Size Diagram	17



PL-C1050 Boiler Controller

Description

The Proton PL-C1050 Boiler controller is a microprocessor-based controller designed to operate staged boilers, as well as the associated pumps and valves. It features a variety of control strategies, including outside temperature reset, lead-lag sequences, pump exercise intervals and more.

General Behaviour

Although fully configurable, the Proton C1050 Boiler controller monitors dedicated inputs and uses pre-established control sequences to drive dedicated outputs to control standard Boiler equipment. These sequences can be fully optimized to obtain the best results for each type of system. Numerous parameters enable the modification or fine tuning of the pumps, the boilers, the target supply temperature, the proportional bands, integration times, differentials, operational ranges, setpoints and a whole range of limits and safeguards. The various programming options also allow the user to modify the lead-lag sequences, conditions for pump activity and the influence of schedules or other data received over the network. All these parameters can be accessed and modified by using the Proton Focus software.





Operating Sequence

General

The Proton C1050 Boiler controller receives readings from three different temperature sensors: outside air, supply water and return water. In addition to the temperature sensors, it also has an input for proof of operation of the pumps. It can receive data from Proton master controllers such as outside temperature, occupancy, or the average heating request of the building. The controller then analyzes all the data and activates the appropriate outputs to respond accordingly, within parameters set by the temperature sensors and other safety limits.

Parallel Pump Sequence

This sequence is intended for hydronic systems where there is a secondary pump that acts as a backup to the primary pump, with both pumps being installed in parallel. The primary pump is activated based on outside temperature or upon a call for heating, or both. The secondary pump will only be activated when there is no proof of operation of the primary pump after a configurable delay.

The pumps can be setup for various lead-lag sequences wherein they will alternate between primary and secondary roles. The pumps can also be exercised after configurable periods of inactivity.

The target supply temperature can be a fixed setpoint or instead follow a reset based on outside temperature. The target supply temperature can also be reduced in unoccupied mode or influenced by a network provided demand, usually representing an average heating request coming from the zones in the building.

Boiler activity is based on a call for heat (i.e. supply temperature is below the target), which can be interlocked with the outside temperature. The C1050 boiler controller can be configured to control up to two boiler stages or can control one modulating boiler with an optional backup stage. Boiler stages can also be set up for various lead-lag sequences that will cycle through the position of the lead boiler stage.

The C1050 boiler controller can also be used to control a three-way valve when configured for staged control, which it will modulate to attain the target temperature.

Follower Pump Sequence

This sequence is intended for hydronic systems where there is a primary and secondary loop. The primary pump is activated based on outside temperature or upon a call for heating, or both. The secondary pump will be activated simply when there is proof of operation of the primary pump.

The pumps can be exercised after configurable periods of inactivity.

The target supply temperature can be a fixed setpoint or instead follow a reset based on outside temperature. The target supply temperature can also be reduced in unoccupied mode or influenced by a network provided demand, usually representing an average heating request coming from the zones in the building.

Boiler activity is based on a call for heat (supply temperature is below the target), which can be interlocked with the outside temperature. The C1050 boiler controller can be configured to control up to two boiler stages or can control one modulating boiler with an optional backup stage. Boiler stages can also be set up for various lead-lag sequences that will cycle through the position of the lead boiler stage.

The C1050 boiler controller can also be used to control a three-way valve when configured for staged control, which it will modulate to attain the target temperature.



Component Identification

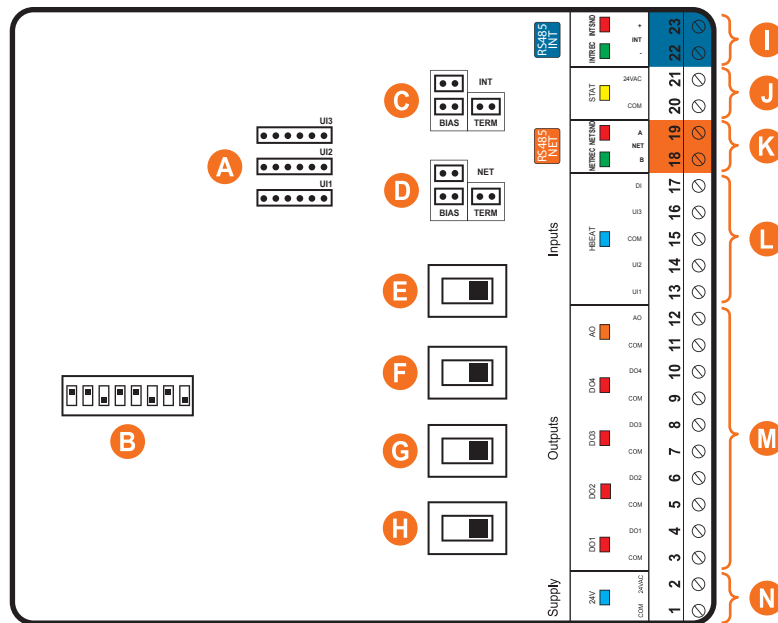

Figure 1 - Component Identification

Legend:

- A** - Analog Input Signal Mode Jumpers
- B** - Addressing dipswitch
- C** - Jumpers for terminating and bias resistors for the INT port (see **I**)
- D** - Jumpers for terminating and bias resistors for the NET port (see **K**)
- E** - SOURCE/SINK dipswitch for Output 4
- F** - SOURCE/SINK dipswitch for Output 3
- G** - SOURCE/SINK dipswitch for Output 2
- H** - SOURCE/SINK dipswitch for Output 1
- I** - INT port for RS485 communication (terminal block)
- J** - Alternate terminal blocks for 24 VAC (provides power to an optional digital sensor)
- K** - NET port for RS485 communication (terminal block)
- L** - Inputs (4 total)
- M** - Terminal Blocks for Outputs 1 to 5
- N** - Terminal Blocks for 24 VAC



LEDs

The C1050 has various LEDs which are linked to different functions and outputs of the controller. Each LED is individually identified to help the user make a quick visual diagnostic of the controller's activity and status.

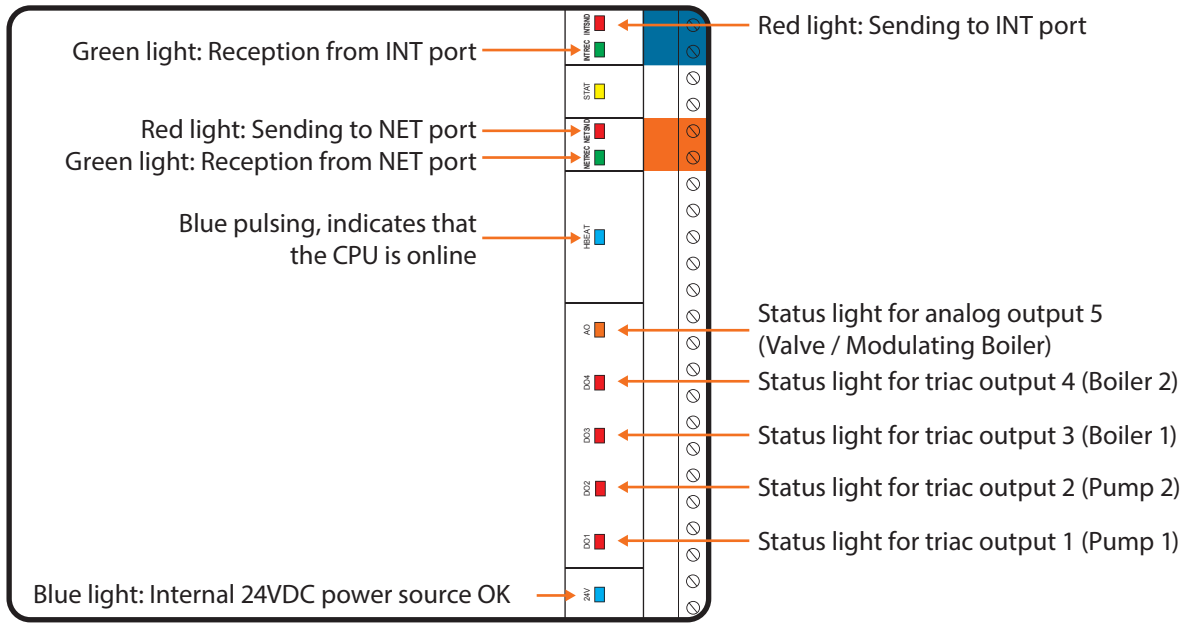

Figure 2 - LEDs Identification

Address Configuration for Networking

A unique address on each controller must be configured by setting the first 7 switches on the addressing dipswitch to the desired value.

These switches are numbered from 1 to 7 and represent a binary value from 1 to 64 (1, 2, 4, 8, 16, 32, 64 respectively). The value of each switch that is in the ON position is added together to form the numerical address of the controller.

The example on Figure 3 shows the switches 1, 2 and 4 on the ON position. So the corresponding values are 1, 2 and 8, giving an address sum of 11. (1+2+8=11)

The Proton network allows a maximum of 127 addresses, therefore 127 controllers.

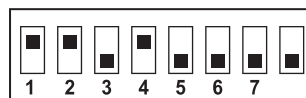

Figure 3 - Addressing Dipswitches



Input and Output Identification

All the inputs and outputs of the C1050 use pluggable screw type terminal blocks with elevator style clamping, which make connections easier and more secure.

The C1050 Boiler Controller has two separate communication ports offering the same functionality on each. Both act as ports for incoming Modbus communications from other Proton devices or interfaces, such as a Network Controller or remote computer with Proton Focus software.

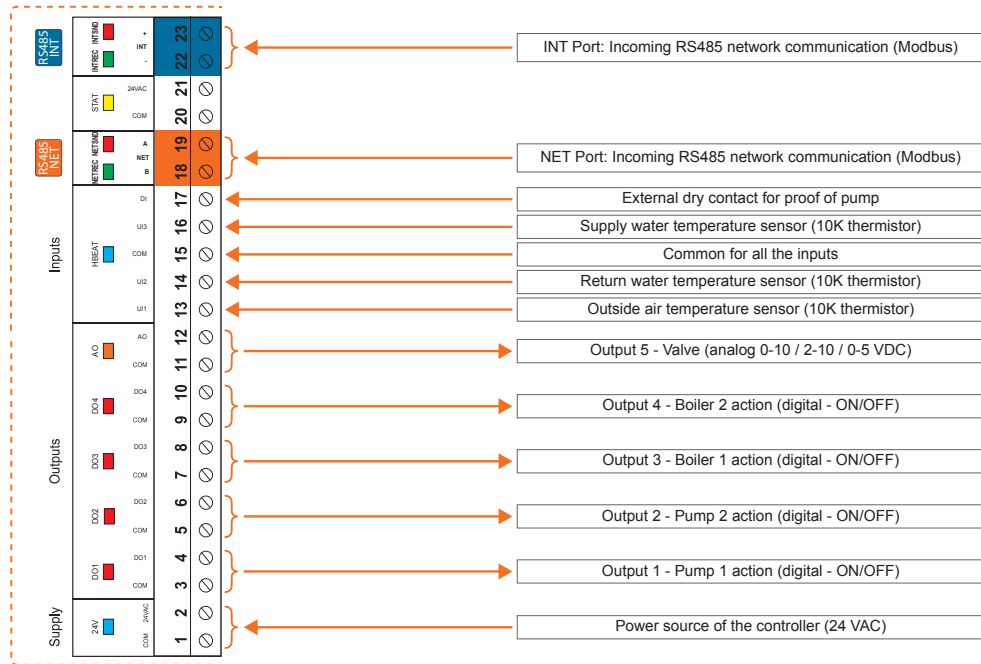

Figure 4 - Input and Output Identification (Staged Boiler)

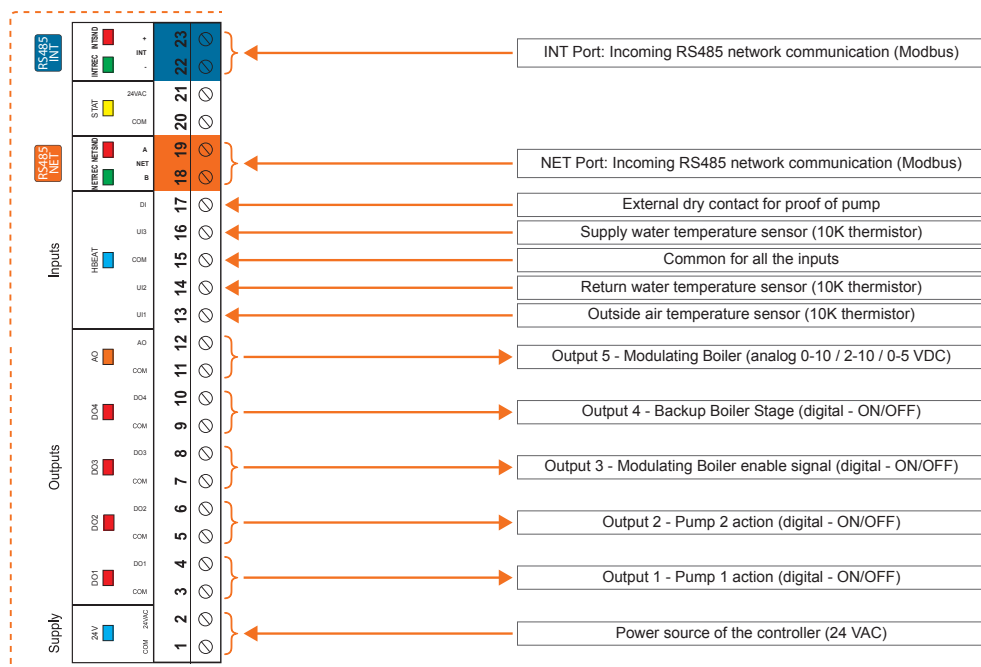

Figure 5 - Input and Output Identification (Modulating Boiler)



Inputs

Analog Input

The C1050 series controllers are equipped with three general purpose analog inputs. These inputs can be configured to receive signals of the following types:

- Thermistor (Ω)
- 0-5V
- 4-20mA
- 0-10V

When a thermistor is used, the thermistor must be 10K Ω TYPE 3.

Each C1050 analog input is equipped with a fast-switching barrier diode to protect against surges and short circuits.

By default, the C1050-BLR analog inputs are set up for thermistor mode. The input signal mode can be changed by setting jumpers U1, U2 and U3, situated inside the casing, in the desired position:

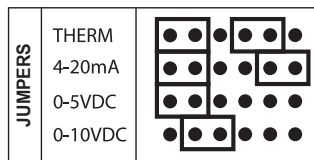

Figure 6 - Analog input

Temperature Sensors

The C1050 Boiler controller has three analog inputs that monitor outside air, supply water and return water temperatures and will integrate these readings into its control sequence. The sensors used are standard 10k type thermistors that share a single common connection.

The outside air temperature can be also be provided by an alternate source. If a network controller is present on the network, it can retrieve the outside temperature reading from one controller and distribute it to any other controllers on the network.

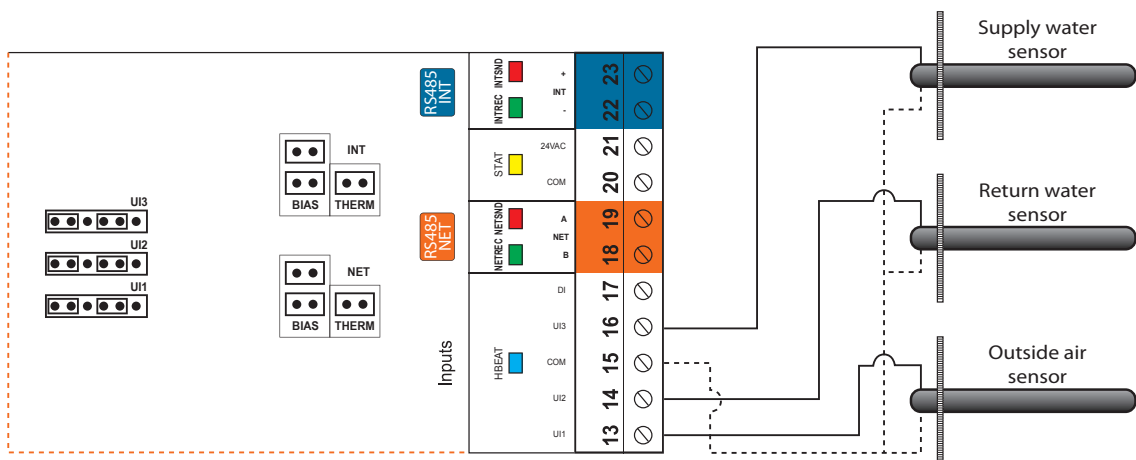

Figure 7 - Connecting the Temperature Sensors



Proof of Pump

The C1050 has one digital input dedicated to the proof of pump signal. Please refer to Figure 9 see how to correctly connect it. To indicate proof of pump, the contact must be closed. If no proof of pump signal is available, you must short the corresponding input, or else the controller will interpret the absence of signal as a pump malfunction and no heating action will be taken.

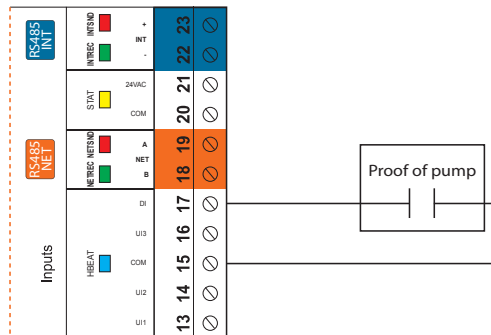

Figure 8 - Connecting the Proof of Pump Contacts to the Controller



Outputs

The C1050 Boiler controller contains 5 customizable outputs; four triac ON/OFF outputs (24VAC) and one analog output (0-10VDC). Output configuration is performed via the ProLon Focus software.

An integrated resettable fuse protects each of the outputs of the C1050 against current surges and short circuits. This protection will cut the current to the output as soon as an overload condition is detected. The fuse is round and yellow-colored which, upon a short circuit condition, will heat up and change to orange. When the faulty wiring or circuit is fixed, the fuse will automatically reset and allow current to flow through the output again.

Output Specifications

Output	Type	Action	Applications
DO 1	Triac Source 24VAC Max Current: 300 mA	On-or-Off	Pump Stage 1
DO 2	Triac Source 24VAC Max Current: 300 mA	On-or-Off	Pump Stage 1
DO 3	Triac Source 24VAC Max Current: 300 mA	On-or-Off	Boiler Stage 1
DO 4	Triac Source 24VAC Max Current: 300 mA	On-or-Off	Boiler Stage 2
AO 1	Configurable Analog Output: - 0 to 10 VDC - 2 to 10 VDC - 0 to 5 VDC Max Current: 40 mA	Modulating Proportional	Three Way Valve or Modulating Boiler

Configuration of Digital Outputs

The digital triac outputs are configurable (SOURCE/SINK) via a switch located on the board. Simply move the switch to obtain either a SOURCE active output (1) or a SINK passive output (2).

1) Switch position to obtain a SOURCE **active output**:

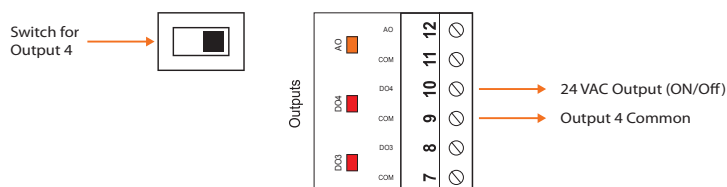

Figure 9 - Output in SOURCE mode



2) Switch position to obtain a SINK *passive output*:

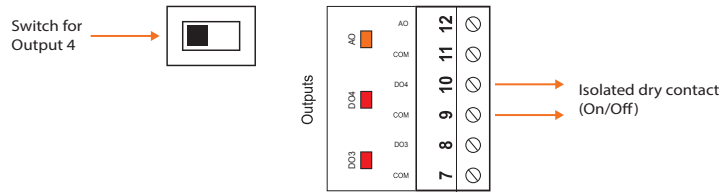

Figure 10 - Output in SINK mode

Typical Connection of Digital Outputs

Two types of configurations are possible:

1) Active output (SOURCE). The C1050 is actively powering the load:

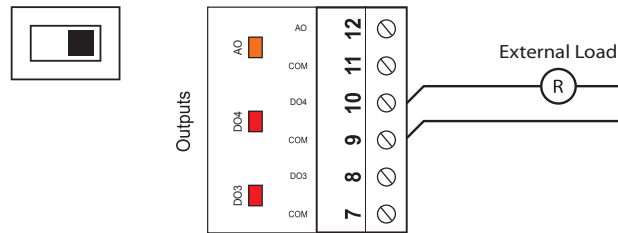

Figure 11 - Connection of Active Outputs 3 and 4

2) Passive output (SINK). The C1050 opens and closes a contact to allow an external source to power the load:

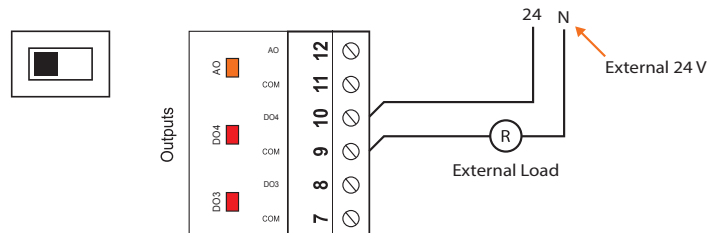

Figure 12 - Connection of Passive Output 3 and 4



Typical Connection of the Analog Output

Two types of configuration are possible:

- 1) The C1050 powers the load and provides a control signal:

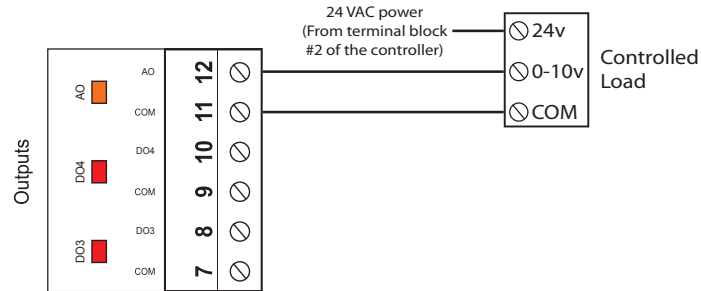

Figure 13 - Connecting the Analog Output (Controller Powered)

- 2) The C1050 only provides the control signal to the load, which is powered by an external source:

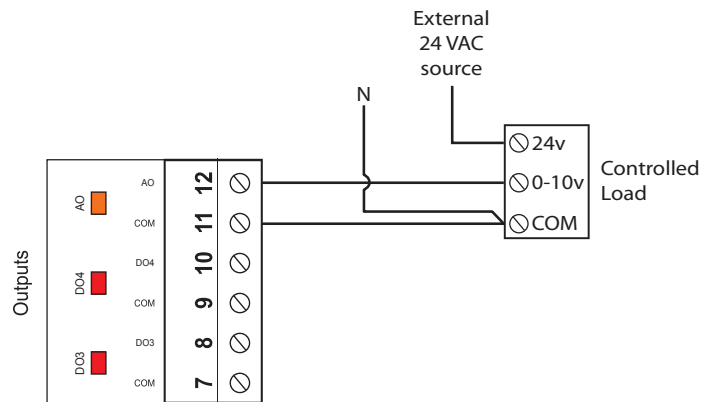

Figure 14 - Connecting the Analog Output (External Power)



Power Source

The Proton C1050 controller is powered by a 24 VAC power source connected using the "COM" terminal and the "24 VAC" terminal (see Figure 15). The common for all inputs and outputs are the same as the power source's common (exception: when an output is set to passive, the common for this output will not correspond to the power source common). All output power sources also originate from the controller's power source.

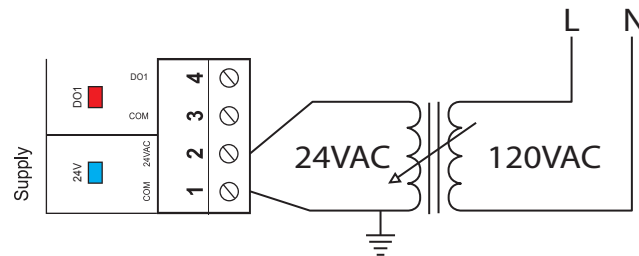

Figure 15 - Connecting the 24VAC Power Source

Network Communication

The Proton C1050 controller works autonomously or networked. When networked, it will communicate in real-time with other controllers. The C1050 controller's default communication protocol is Modbus RTU over RS485. The addressing is done with the addressing dipswitch located on the C1050 card (see Figure 3). The network connections are made using the NET terminal block located on the Proton C1050 controller (see Figure 16).

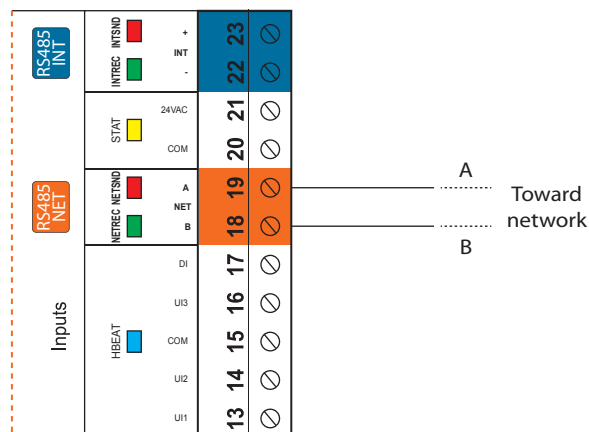

Figure 16 - Connecting to the Network



Technical Specifications

Supply: 24 VAC \pm 10%, 50/60 Hz, Class 2

Consumption: 2 VA (Consumption), 32 VA (Input)

Inputs: Outside air – 10K thermistor
Return Water – 10 K thermistor
Supply Water – 10 K thermistor
Proof of pump – dry contact

Digital outputs: 4 triac outputs, 10-30 VAC source or sink, 300 mA max (resettable fuse)

Analog output: 1 output 0-10 VDC / 2-10 VDC / 0-5 VDC, 40 mA max (resettable fuse) for the valve

Indication lights (LED): State of each output / Communication / Supply / State of microprocessor

Microprocessor: PIC18F6722, 8 bits, 40 MHz, 128KB FLASH memory

Casing: Molded ABS, UL94-HB

Communication: Modbus RTU (RS485), up to 127 nodes

Baud rate: 9600, 19200, 38400, 57600, 76800, 115200

Connection: Removable screw-type terminal blocks (16 AWG max)

Dimensions: 6.2" x 5.2" x 2.5" (157 mm x 132 mm x 64 mm)

Weight: 0.85 lbs (0.39 kg)

Environment: -4 to 122 °F (-20 to 50 °C) Non-Condensing

Certification: UL916 Energy Management Equipment, CAN/CSA-C22.2, RoHS, FCC part 15: 2012 class B

The performance specifications are nominal and conform to acceptable industry standards. Prolon Inc. will not be liable for damages resulting from misapplication or misuse of its products.



Compliance

- FCC Compliant to CFR47, Part 15, Subpart B, Class B
- Industry Canada (IC) Compliant to ICES-003, Issue 5: CAN ICES-3 (B)/NMB-3(B)
- RoHS Directive (2002/95/EC)

FCC User Information

This device complies with Part 15 of the FCC Rules. Operation is subject to the following two conditions: (1) this device may not cause harmful interference, and (2) this device must accept any interference received, including interference that may cause undesired operation.

Caution: Any changes or modifications not approved by Prolon can void the user's authority to operate the equipment.

Note: This equipment has been tested and found to comply with the limits for a Class B digital device, pursuant to part 15 of the FCC Rules. These limits are designed to provide reasonable protection against harmful interference in a residential installation. This equipment generates, uses and can radiate radio frequency energy and, if not installed and used in accordance with the instructions, may cause harmful interference to radio communications. However, there is no guarantee that interference will not occur in a particular installation. If this equipment does cause harmful interference to radio or television reception, which can be determined by turning the equipment off and on, the user is encouraged to try to correct the interference by one or more of the following measures:

- Reorient or relocate the receiving antenna.
- Increase the separation between the equipment and receiver.
- Connect the equipment into an outlet on a circuit different from that to which the receiver is connected.
- Consult the dealer or an experienced radio/TV technician for help.

Industry Canada

This Class (B) digital apparatus meets all the requirements of the Canadian Interference-Causing Equipment regulations.

Cet appareil numérique de la Classe (B) respecte toutes les exigences du Règlement sur le matériel brouilleur du Canada.



Overall Dimensions

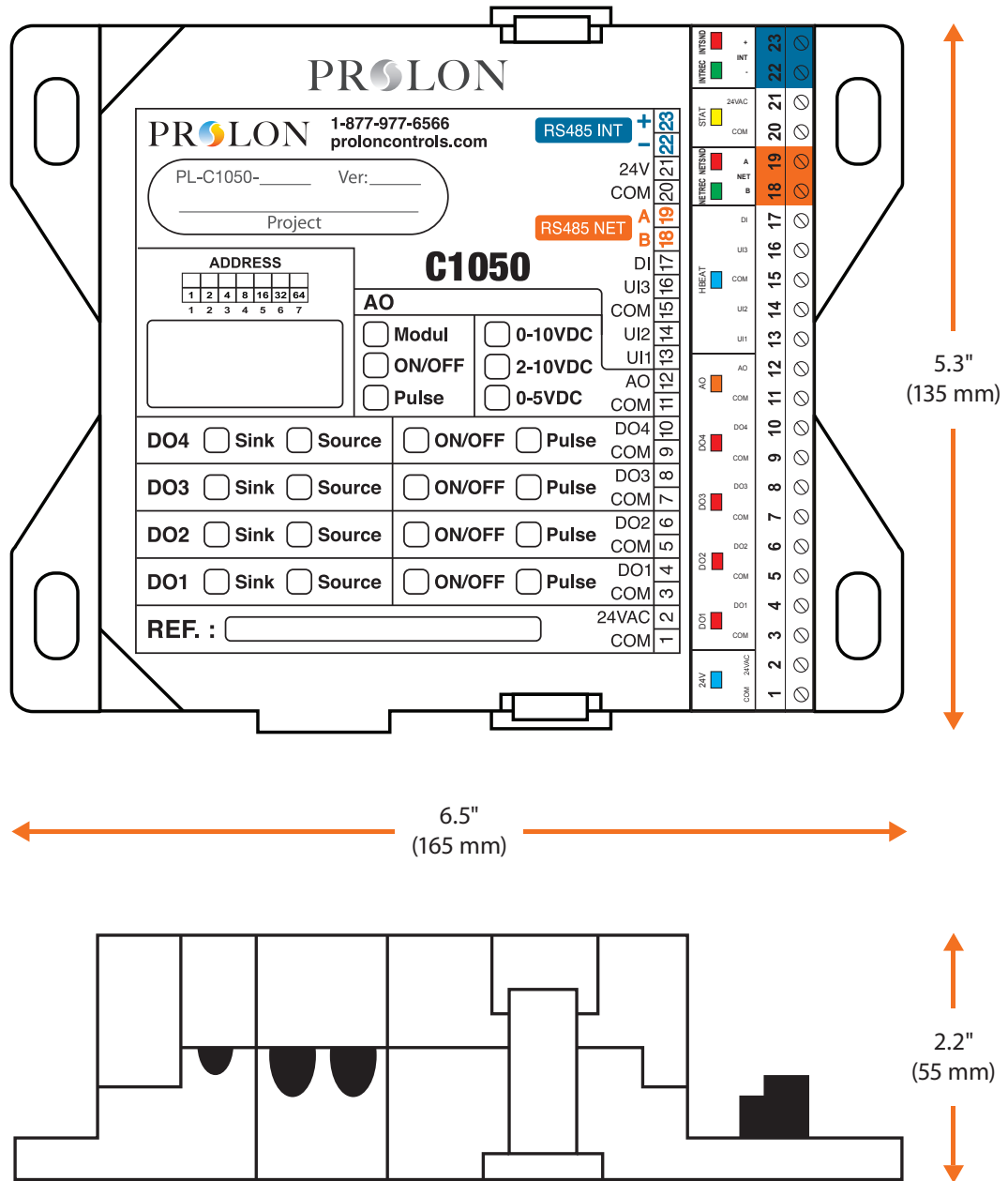

Figure 17 - C1050 Size Diagram

REV. 7.3.2

PL-HRDW-BLR-C1050-C/F-EN

© Copyright 2023 Prolon. All rights reserved.

No part of this document may be photocopied or reproduced by any means, or translated to another language without prior written consent of Prolon. All specifications are nominal and may change as design improvements are introduced. Prolon shall not be liable for damages resulting from misapplication or misuse of its products. All trademarks are the property of their respective owners.